



671 Series

Dimmable LED PSU (16.8-150V DC)

Feature Summary

- Constant current output compatible with standard LED lighting products.
- Output current dimmable down to 10mA.
- Ultra-high reliability design — 350,000 hours MTBF*.
- Operational across a wide range of power supply voltages.
- Capable of driving up to 15 LEDs†.



Product Codes

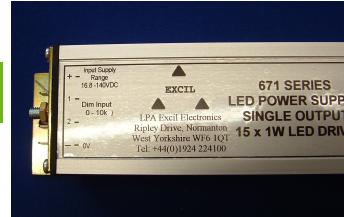
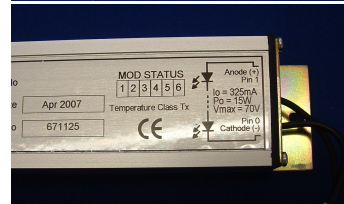

Long Life Reliability
does not cost the earth

LPA-EXCIL ELECTRONICS



671 Product Range Standard Features		
Input Voltage Range	16.8-150	V DC
Enclosure Type	Sealed Aluminium Extrusion (Figure 1)	
Input Connector	Faston Blades	
Output Connector	Flying Lead w/ Entelec MF16 Connector	

Product Code #	671 125
Max No. LEDs driven‡	15
Max Output Power Rating	15W

* MTBF calculated using US MIL-217F GM standard @ 40°C.

† Assuming single 1W LEDs.

Input Specification

	All Variants	
Acceptable Input Supply Voltage Range	16.8-150	V DC
Input Voltage Limit Without Damage	165	V DC

	All 671 Series Variants					
Number of LEDs	1	3	5	10	15	
DC Input Current (@ 52V DC)*	32	97	162	320	480	mA DC
DC Input Current (@ 110V DC)*	15	46	76	150	230	
Quiescent Current (No Load)*	32					

	All Variants	
Peak Inrush Current	70 (@ 140V DC)	A
Time to Half Value	200 (@ T=25°C)	µs

Output Specification†

		LED Quantity					
		1	3	5	10	15	
Maximum LED Current		350					mA
Minimum LED Current		10					
Nominal Output Voltage†	White LED	3.42	10.26	17.1	34.2	51.3	V DC
	Red LED	2.95	8.85	14.75	29.5	44.25	
	Green LED	3.42	10.26	17.1	34.2	51.3	
	Amber LED	2.95	8.85	14.75	29.5	44.25	
Maximum Output Voltage		70					V DC
Short Circuit Current		350					mA

To reduce the output current, add a resistor of appropriate value (see graph) across input faston blades 1 and 2. Leaving faston blades 1 and 2 open circuit results in maximum output current (350mA).

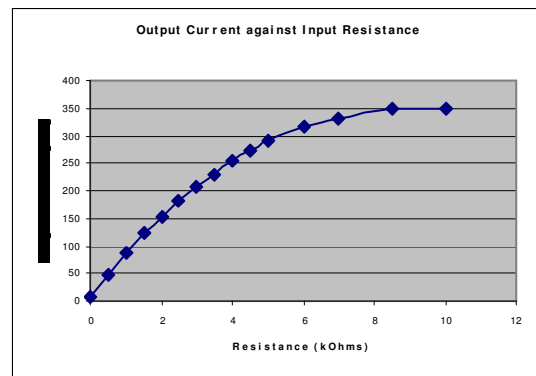

* Input current values across the entire operational voltage range are available on request

† Quoted voltage figures apply to Lumiled IW LEDs.



Environmental Specification

All Variants			
Unit Weight		425	g
Dry Heat (steady state)	RIA13 1990 1995	70	°C
		6	Hrs
Sealing Rating		IP65	
Shock and Vibration		EN50155 & EN61373	
Operating Temperature Range		-30 to 70	°C
MTBF Ground Mobile 40°C		350,000	Hrs

Compliance

The 671 Series LED power supply complies with the following standards:

- EN50121-3-2
- RIA12 (Note: Surge A has only been tested at -52VDC)
- EN61373
- EN50155
- EN60529 to IP65

Safety Specification

All 671 Series variants come equipped with the following protection circuitry as standard:

- DC input voltage reversal (Non destructive).
- Output short circuit protection.
- Load inrush protection.
- Input and output transient protection.
- Under voltage cut-off.

* All immunity tests comply with performance criteria 'A'

Installation Guide

General Installation Notes: 671 Series Products

Maximum Supply Cable Impedance		
No. PSUs	Input Voltage V DC	Impedance Ω^*
1	16-40	0.5
1	40-140	2

On all 671 Series Products the positive and negative pins on each input Faston are internally connected together as shown below:

Installation Diagram - 671 I25 product, single PSU module

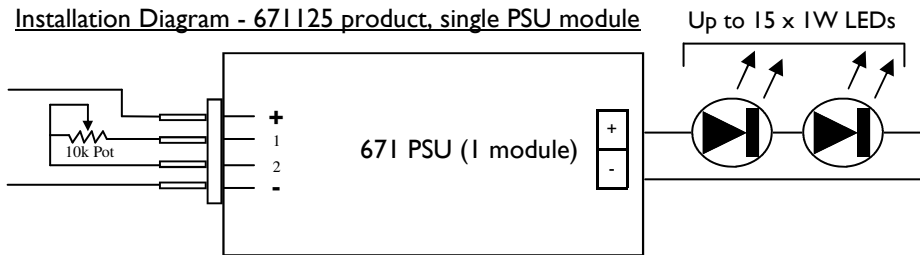

Output Connector Pin Out - Entrelec MF16	
Pin 0	-ve
Pin 1	+ve

* Source impedance value MUST be divided by the number of PSUs on each supply cable

Mechanical Specification

All Dimensions in mm unless stated otherwise

Figure 1 - Enclosure Details for 67125 LED PSU
0.25" Faston Blades & Entrelec MF16 Connectors

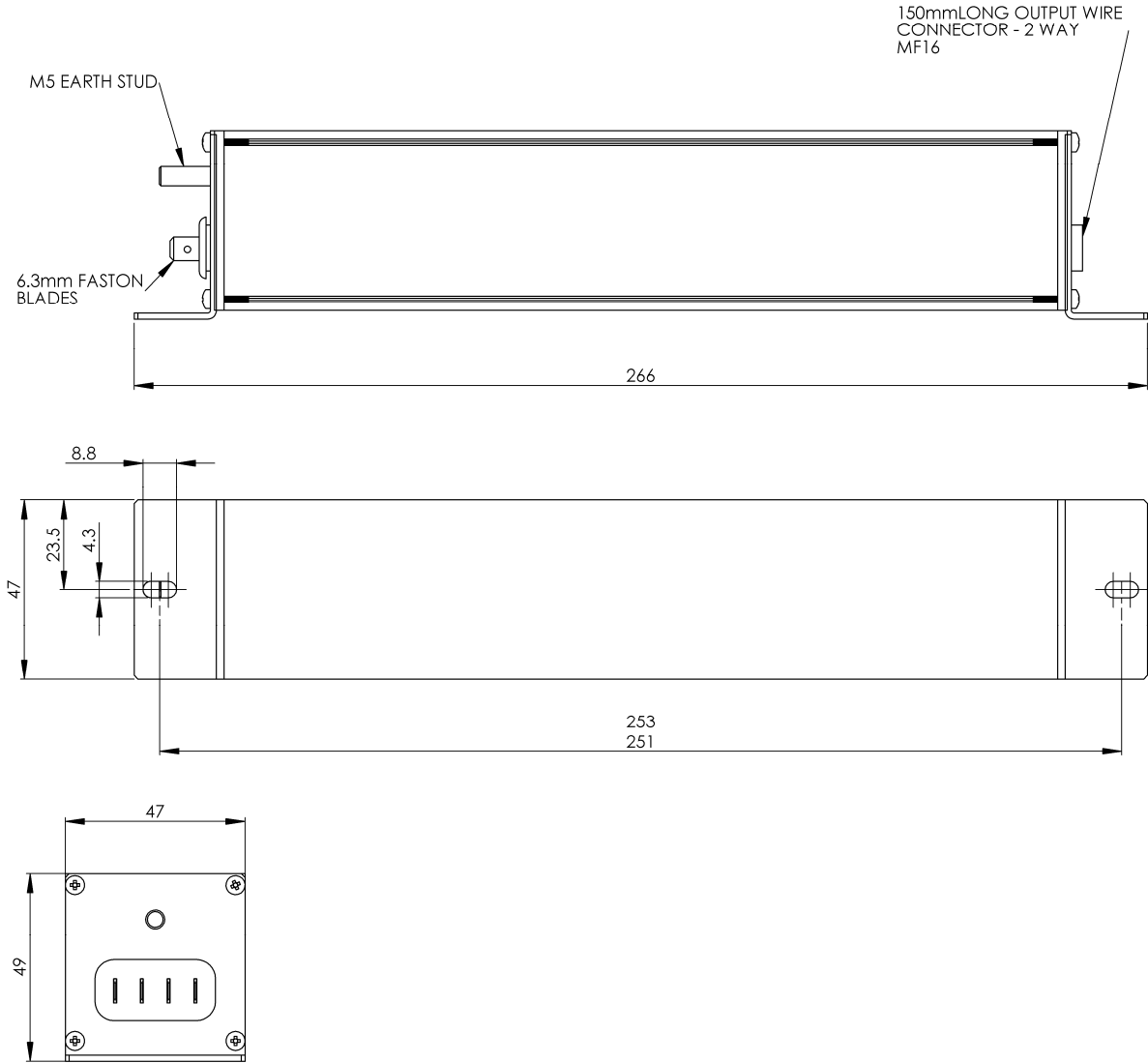

LPA-Excil makes every effort to ensure the accuracy of the information contained within this datasheet. However we reserve the right to withdraw and re-issue this datasheet at a later date.



LPA-Excil Electronics
Ripley Drive, Normanton,
WF6 1QT, UK
Tel: +44 (0)1924 224100
Fax: +44 (0)1924 224111

LPA Excil Electronics is a member of the LPA group