



Contents

Aviation Plugs & Sockets Range	2
Socket & Plug Selector	4
PDS400 Connector (400 Hz)	6
PD400 Connector (400 Hz)	10
P400 Connector (400 Hz)	12
Short Nose Socket (400 Hz)	14
Connector Plugs (400 Hz)	16
28VDC 3 Pole Connector	18
Cable Assemblies & Harnesses	22
PFR400 Flanged Receptacle	32
28VDC Flanged Plug & Socket	34
400 Hz Flanged Plug & Socket	36
Flanged Connector Mounting Boxes	38
Spares & Accessories	40
Technical Information	44
NATO Stock References	45

Aviation Plugs, Sockets, Cable Assemblies & Spares

LPA Group has over 70 years experience in power connection solutions for the aviation sector. The company has an ethos of designing and manufacturing products offering high reliability, with low maintenance and life cycle costs.

LPA's worldwide network of customers comprises of major UK and international airports, OEMs, specialist aviation suppliers and the military. We recognise the importance of reliable power systems in these dynamic environments and ensure our range of power connector and cable harnesses can exceed these demanding expectations.

LPA's aviation products are designed to support the efficiency and safety of the ground handling staff and GPU equipment in use on airport aprons.

Our aviation connector range is designed and manufactured to ISO 461-1, ISO 461-2, BS 43 173 part 1. LPA is EN 9100, ISO 9001 and ISO 14001 certified.

Aviation Plugs & Sockets



115 - 200VAC 400 Hz 6 Pole & 28VDC 3 Pole Connectors.

- Plane Power 400 Hz connectors and 28VDC plugs and sockets
- External components are manufactured from impact, abrasion and chemically resistant, thermally stable polymers
- Modular connector construction. Replacement parts include noses, handles, switches, LED's and contact tubes
- IP66 and IP67 rated (no filler required with Plane Power connectors - independent IP certificate available on request)
- Suitable for a wide range of composite and single core cables

Socket/Plug Selector

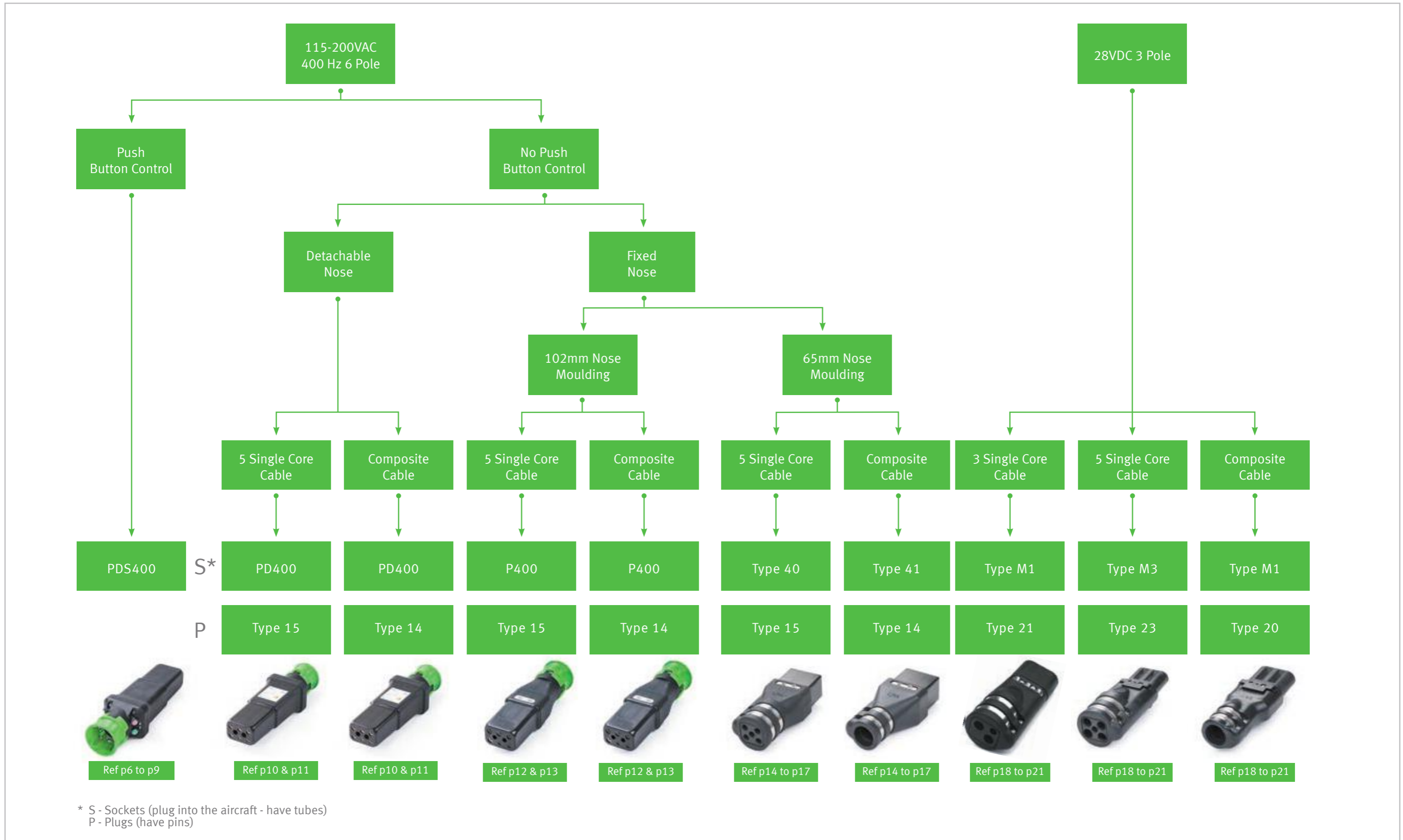

* S - Sockets (plug into the aircraft - have tubes)
P - Plugs (have pins)

PDS400 Connector (400 Hz)

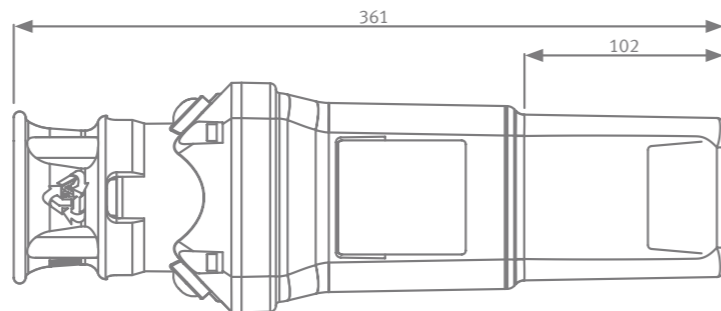
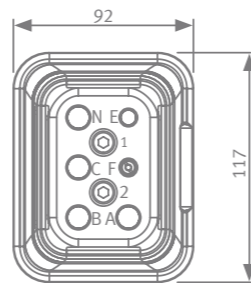

All dimensions in mm

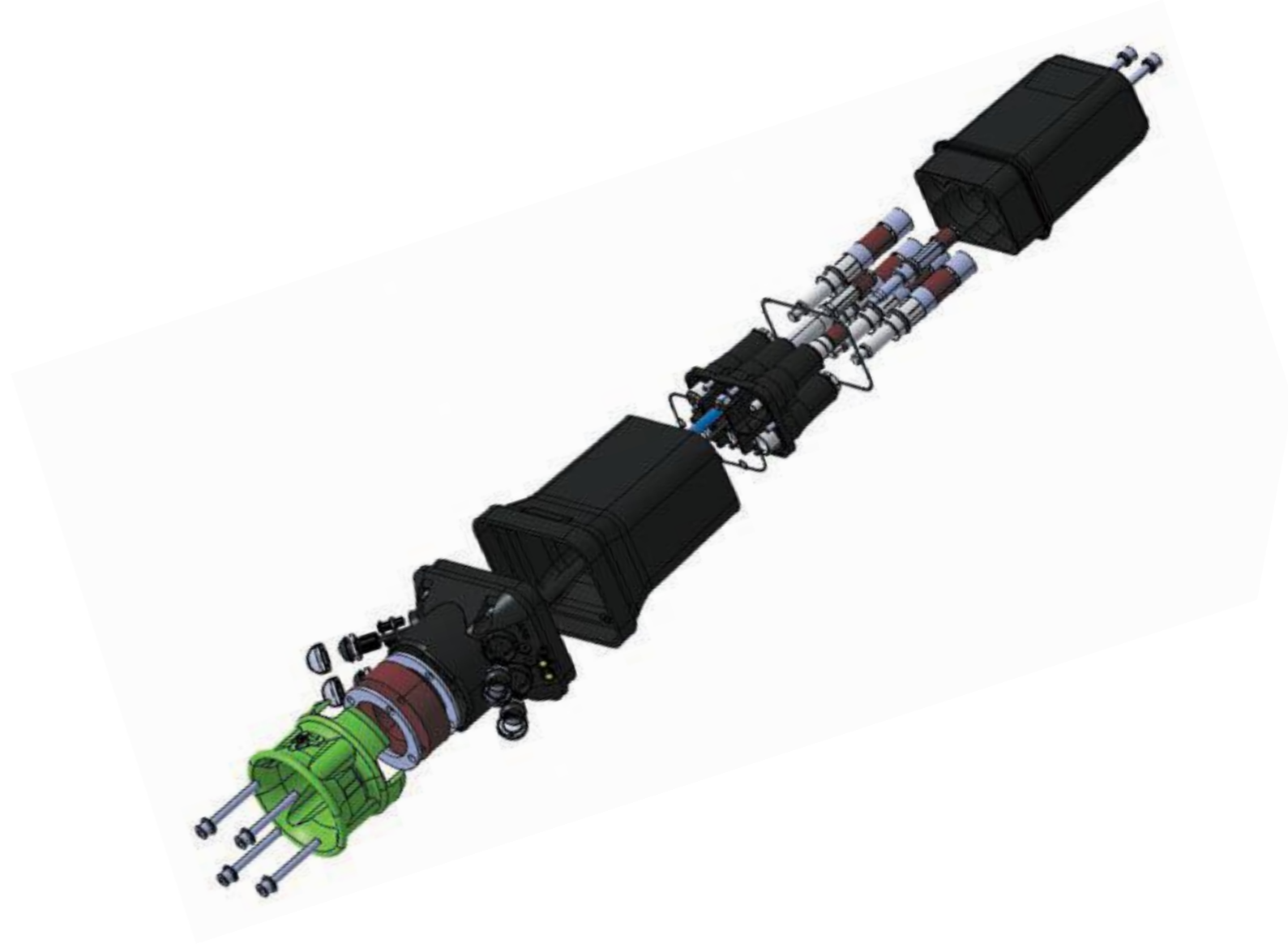

Detachable front nose & push button controls.

The PDS400 connector comes with detachable front nose and push-button controls.

Features:

- Configurable to meet customer requirements
- Low maintenance
- Impact resistant
- External components manufactured from impact, abrasion and chemically resistant, thermally stable polymers
- Detachable power/control contacts and contact insulator (nose) are easy to maintain and replace
- LEDs and push-button switches are individually replaceable
- Suitable for a wide range of composite and single core 400 Hz cables
- Exterior replaceable handle/strain relief system
- IP66 & IP67 rated (filler not required)

Technical information:

- High conductivity silver plated copper contacts
- Configurable switches and LEDs to provide control and indication of connector usage
- Micro-switch (replaceable) located within the 'F' contact provides a signal once the connector has been inserted 90% into the mating receptacle (optional feature)
- Optional temperature sensors fitted to A, B and C contacts can prevent overheating if wired correctly into Power Supply
- Switch 'boots/hoods' provide ingress protection for the external faces of the switches
- Nominal voltage: 115/200 V, 400 Hz
- Current carrying capacity (cont): 450 A (power), 35 A (control)
- Current overload: 1500 A for 1 min (power)

- High-voltage test: 4000 V
- Operating temperature: -25°C to +90°C (includes temperature rise)
- Mating forces: As per ISO 461 – 1
- Weight: 2.5 kg
- Applicable standards: ISO 461-1, ISO 461-2, BS 4G 173-1, VG 96966-1, MIL-C-7974D
- Compatibility: Mates with ISO 461-2 and MS90362 receptacles

PDS400 Connector (400 Hz)



PDS400 with Exohook hanging from PJS400 Junction Sleeve

1	Standard control tube	0	No LEDs	1	ON (normally open), OFF (normally closed)
2	90% insertion tube with removable switch	1	1 LED colour red	2	ON (normally open), OFF (normally open)
		2	2 LEDs colours red & green		
		3	3 LEDs colours red & green + 1 yellow		
		4	4 LEDs colour red & green + 2 yellow		
		5	1 LED colour green		
		6	4 LEDs colours red & green + yellow & green		
		7	1 LED colour yellow		
				0	No temperature sensors required
				1	PT100
				2	PTC120
				3	PTC100



Conductor sizes mm ²		
1	A, B & C N	70mm ² 70mm ²
2	A, B & C N	70mm ² 35mm ² /50mm ²
3	A, B & C N	35mm ² /50mm ² 35mm ² /50mm ²
4	A, B & C N	35mm ² /50mm ² 30mm ² /33mm ²
5	A, B & C N	30mm ² /33mm ² 25mm ²
6	A, B & C N	35mm ² /50mm ² 25mm ²

A	To suit 1 x Ø 34.00-35.99mm cable
B	To suit 1 x Ø 36.00-37.99mm cable
C	To suit 1 x Ø 38.00-39.99mm cable
D	To suit 1 x Ø 40.00-41.99mm cable
E	To suit 1 x Ø 42.00-44.99mm cable
F	To suit 3 x Ø 19.00-20.99mm cable
G	To suit 3 x Ø 21.00-23.00mm cable
H	To suit 4 x Ø 16.00-17.99mm cable
J	To suit 4 x Ø 18.00-19.99mm cable
K	To suit 4 x Ø 20.00-22.00mm cable

0	No push buttons
1	1 push button - green
2	2 push buttons - green & red
3	3 push buttons - green, red & black
4	4 push buttons - green, red & 2 black
5	2 push buttons - 2 black

Cable length in metres e.g. add 10
Only required for connector with cable

- Add F - lanyard fitting required.
- Add L - harness connector control contacts to be linked.
- Add N - harness connector neutral rupture to be wired.
- Add LN - harness connector contacts linked + neutral rupture to be wired.

Example codes:
Connector only
 PDS400/2143C2 - Cable size 70mm² A, B & C, 35/50mm² neutral, standard control tube, 4 push buttons, 3 LEDs, bung to suit cable size 1 X Ø 38.00 – 39.99mm, PTC120 temperature sensors.
Connector with cable
 PDS400/2240J0/10/1 - Cable size 70mm² A, B & C, 35/50mm² neutral, 90% insertion tube, 4 push buttons, 0 LEDs, bung to suit cable size 4 x Ø 18.00-19.99mm, no temperature sensor, 10m cable, switch wiring ON (Normally open) OFF (normally closed).

PD400 Connector (400 Hz)

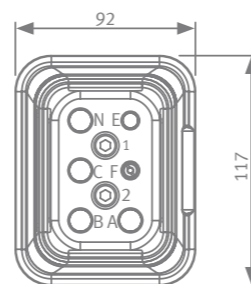
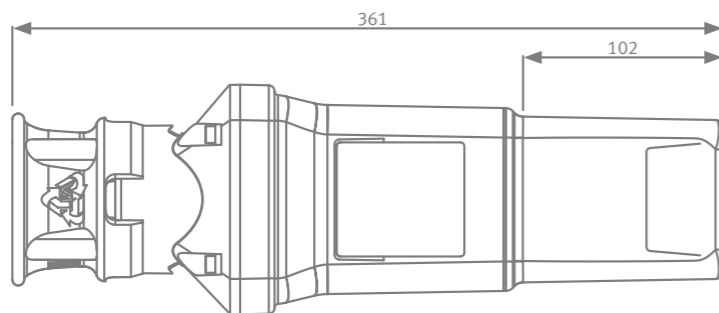

All dimensions in mm

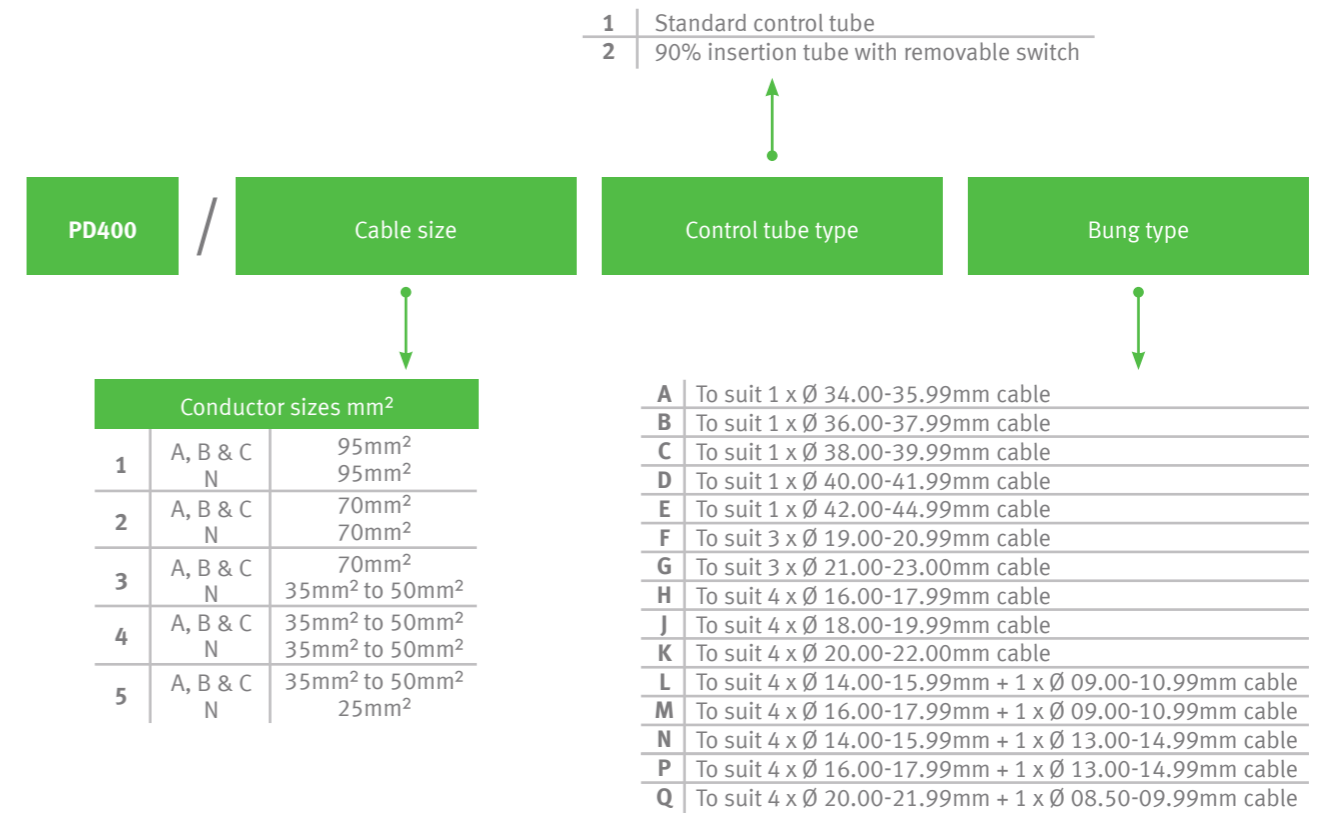

Supplied with detachable front nose.

The PD400 connector is supplied with a detachable nose & replacement front contacts.

Features:

- Detachable power/control contacts and contact insulator (nose) are easy to maintain and replace
- Suitable for a wide range of composite and single core 400 Hz cables
- External components manufactured from impact, abrasion, and chemically resistant, thermally stable polymers
- Exterior replaceable handle/strain relief system
- IP66 & IP67 rated (no filler required)

Technical information:

- High conductivity silver-plated copper contacts
- Micro-switch (replaceable) located in F contact provides an indication once the connector has been 90% inserted into the mating receptacle (optional feature)
- Nominal voltage: 115/200 V, 400 Hz
- Current carrying capacity: 450 A (power), 35 A (control)
- Current overload: 1500 A for 1 min (power)

- High-voltage test: 4000 V
- Operating temperature: -25°C to +90°C (includes temperature rise)
- Mating forces: As per ISO 461-1
- Weight: 2.30 kg
- Applicable standards: ISO 461-1, ISO 461-2, BS 4G 173-1, VG 96966-1, MIL-C-7974D
- Compatibility: Mates with ISO 461-2 and MS90362 receptacles

P400 Connector (400 Hz)

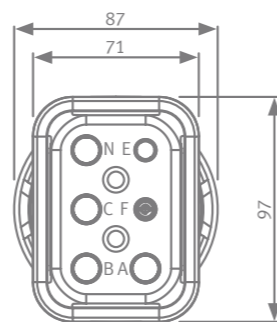
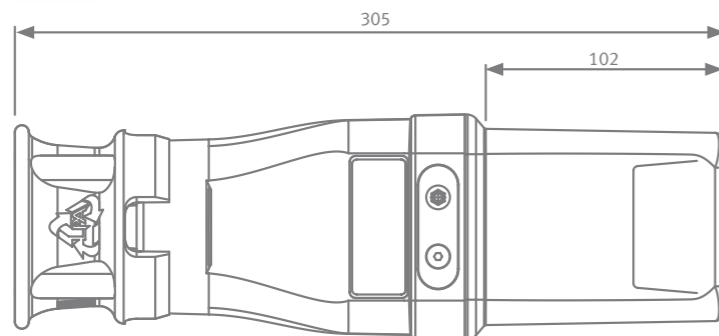

All dimensions in mm

1		Standard control tube	
2		90% insertion tube with removable switch	

P400	Cable size	Control tube	Bung size
Conductor sizes mm ²			
1	A, B & C N	95mm ² 95mm ²	A To suit 1 x Ø 34.00-35.99mm cable B To suit 1 x Ø 36.00-37.99mm cable C To suit 1 x Ø 38.00-39.99mm cable
2	A, B & C N	70mm ² 70mm ²	D To suit 1 x Ø 40.00-41.99mm cable E To suit 1 x Ø 42.00-44.99mm cable
3	A, B & C N	70mm ² 35mm ² to 50mm ²	F To suit 3 x Ø 19.00-20.99mm cable G To suit 3 x Ø 21.00-23.00mm cable
4	A, B & C N	35mm ² to 50mm ² 35mm ² to 50mm ²	H To suit 4 x Ø 16.00-17.99mm cable J To suit 4 x Ø 18.00-19.99mm cable
5	A, B & C N	35mm ² to 50mm ² 25mm ²	K To suit 4 x Ø 20.00-22.00mm cable L To suit 4 x Ø 14.00-15.99mm + 1 x Ø 09.00-10.99mm cable M To suit 4 x Ø 16.00-17.99mm + 1 x Ø 09.00-10.99mm cable N To suit 4 x Ø 14.00-15.99mm + 1 x Ø 13.00-14.99mm cable P To suit 4 x Ø 16.00-17.99mm + 1 x Ø 13.00-14.99mm cable Q To suit 4 x Ø 20.00-21.99mm + 1 x Ø 08.50-09.99mm cable

Supplied with fixed electrical contacts.

The P400 connector comes with fixed electrical contacts, providing a cost-effective connection system to power aircraft.

Features:

- Easy connection to cable
- Low maintenance
- External components manufactured from impact, abrasion and chemically resistant, thermally stable polymers
- Suitable for a wide range of composite and single core 400 Hz cable
- Exterior replaceable handle/strain relief system
- IP66 & IP67 rated (filler not required)

Technical information:

- High conductivity silver plated copper contacts
- Nominal voltage: 115/200 V, 400 Hz
- Current carrying capacity: 450 A (power), 35 A (control)
- Current overload: 1500 A for 1 min (power)
- High-voltage test: 4000 V
- Operating temperature: -25°C to +90°C (including temperature rise)
- Weight: 2.45 kg

- Applicable standards: ISO 461-1, ISO 461-2, BS 4G 173-1, VG 96966-1, MIL-C-7974D
- Compatibility: Mates with ISO 461-2 and MS90362 receptacles

Short Nose Socket (400 Hz)



Type 40

5 Single Core Cable Types

Cable size mm ²	Cable dia mm min/max	Socket order ref	Front half	Rear half	Power tube	Control tube	5 hole bung	Socket protection cap
4 X 95	14.5/18.0	40/1						
4 X 95	18.0/21.0	40/2	28845	27589	27920	26374	28721	29598
4 X 70	14.5/18.0	40/3	27298	27589	26373	26374	18286	29598
4 X 70	18.0/21.0	40/4	27298	27589	26373	26374	28721	29598
4 X 50	11.0/14.5	40/5	27418	27589	27089	26374	27628	29598
4 X 50/35	14.5/18.0	40/6	27418	27589	27089	26374	28721	29598
4 X 50/35	18.0/21.0	40/7	27418	27589	27089	26374	18286	29598

Composite Cable Types

Cable size mm ²	Cable dia mm min/max	Socket order ref	Front half	Rear half	Power tube	Control tube	Socket protection cap
4 X 95	44.0/52.0	41/1					
4 X 95	44.0/52.0	41/2	28845	27592	27920	26374	29598
4 X 70	44.0/52.0	41/2	27298	27592	26373	26374	29598
4 X 50/35	34.0/43.0	41/3	27418	27236	27089	26374	29598



Type 41



Fixed short nose 400 Hz socket.

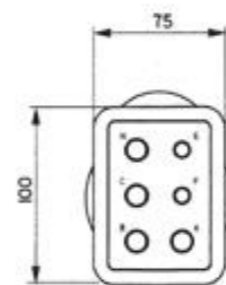
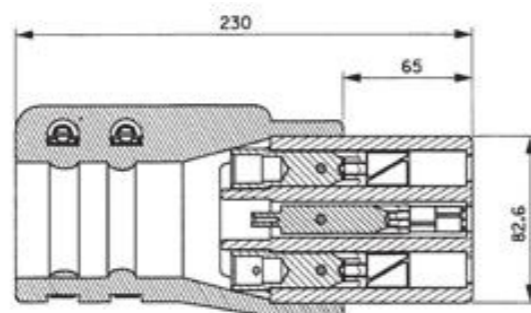

All dimensions in mm

Features:

- The front moulding on Type 40 & 41 sockets is shorter (65mm) than the other connectors (103mm)
- Rear assemblies complete with screw clips, clamping plates, nuts & bolts
- Front assemblies complete with power & control tubes
- Type 40 rear assembly, specify bung reference according to cable size

- Contacts can be either crimped or soldered
- Average weight: 2.3kg
- Exterior material: CSPE

Technical information:

- 115-200VAC
- Power components**
- 450 amps, maximum continuous current
- 1500 amps for maximum 1 minute

Control components

- 35 amps maximum continuous current
- Applicable standards: ISO 461-1, ISO 461-2, BS 45 173
- Compatibility: Mates with ISO 461-2

Connector Plugs (400 Hz)



Type 15 Plug



Type 14 Plug



5 Single Core Cable Types

Cable size mm ²	Cable dia mm min/max	Plug order ref	Front half plug	Rear half assembly	Power pin	Control pin	5 hole bung
4 X 95	14.5/18.0	15/1					
4 X 95	18.0/21.0	15/2	28727	27589	28377	26675	28721
4 X 70	14.5/18.0	15/3	27299	27589	26674	26675	18286
4 X 70	18.0/21.0	15/4	27299	27589	26674	26675	28721
4 X 50/35	11.0/14.5	15/5	28726	27589	26674	26675	18286
4 X 50/35	14.5/18.0	15/6	28726	27589	27884	26675	27628
4 X 50/35	18.0/21.0	15/7	28726	27589	27884	26675	28721
							18286

Composite Cable Types

Cable size mm ²	Cable dia mm min/max	Plug order ref	Front half plug	Rear half assembly	Power pin	Control pin
4 X 95	44.0/52.0	14/1				
4 X 70	44.0/52.0	14/2	27299	27592	26674	26675
4 X 50/35	34.0/43.0	14/3	28726	27236	27884	26675
3 X 35/50 1 X 25	34.0/43.0	14/5	-	27236	3 x 27884 1 x 44388	26675
3 X 70 1 X 35/50	34.0/43.0	14/6	44959	27236	3 x 26674 1 x 27884	26675
4 X 70	34.0/43.0	14/7	27299	27236	26674	26675

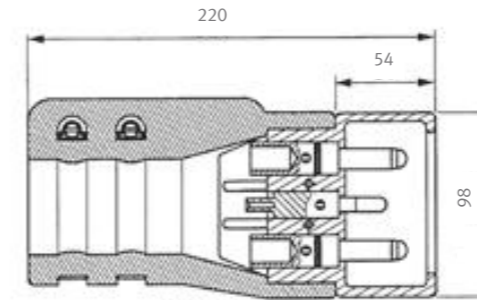

Type 14 Plug

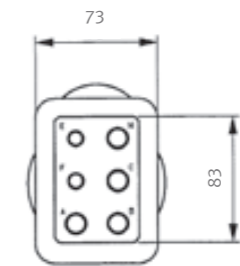

All dimensions in mm

Features:

- Rear assemblies complete with screw clips, clamping plates, nuts & bolts
- Front assemblies complete with power & control pins or tubes
- Contacts can be either crimped or soldered
- Available with protection cap (part number - 29598)

Technical information:

- Plug weight: 1.9kg
- Exterior material: CSPE
- High-voltage test: 4000 V
- Operating temperature: -25°C to +90°C (including temperature rise)

Power components

- 450 amps, maximum continuous current
- 1500 amps for maximum 1 minute

Control components

- 35 amps maximum continuous current

28VDC 3 Pole Connector



Type M1 Socket



Type 20 Plug



Type M3 Socket



Type 23 Plug



Supplied with fixed electrical contacts and split control contact.

Suitable for a wide range of composite, 3 or 5 core cable types.

Features:

- Composite, 3 or 5 single core harness entry
- Split control pins & tubes
- Square bung fitted with removable plug to accommodate control cable
- Rear assemblies complete with screw clips, clamping plates, nuts & bolts
- Front assemblies complete with power & control pins or tubes

- Single contacts can be either crimped or soldered (double contacts must be soldered).
- Average weight: plug - 1.4kg, socket - 1.6kg
- Exterior material: CSPE

Technical information:

Power components

- 450 amps, maximum continuous current

- 1500 amps for maximum of 1 minute

Control components

- 35 amps continuous current
- Applicable standards: ISO 461-1, ISO 461-2, BS 45 173
- Compatibility: mates with ISO 461-2

28VDC 3 Pole Connector



Type M1 Socket



Type 21 Plug



Composite Cable Types

Cable size mm ²	Cable dia mm min/max	Socket order ref	Single end socket front	Rear half	Power tube	Plug order ref	Single end plug front	Rear half	Power pin
2 X 120	41/ 54	M1/A							
2 X 95	41/ 54	M1/B	28682	28703	28686	20/A	28711	28703	28707
2 X 70	29/40	M1/C	28683	28703	27920	20/B	28712	28703	28708
2 X 50/35	29/40	M1/D	28684	28701	26373	20/C	28713	28701	28709
2 X 50/35	29/40	M1/D	28685	28701	27089	20/D	28714	28701	28710

3 Single Core Cable Types

Cable size mm ²	Cable dia mm min/max	Socket order ref	Single end socket front	Rear half	Power tube	3 hole bung	Plug order ref	Single end plug front	Rear half	Power pin	3 hole bung
2 X 120	15.5/20.0	M1/1									
2 X 120	20.0/24.5	M1/2	28682	28723	28686	28678	21/1	28711	28723	28707	28678
2 X 120	24.5/29.0	M1/3	28682	28723	28686	28679	21/2	28711	28723	28707	28679
2 X 95	15.5/20.0	M1/4	28682	28723	28686	28680	21/3	28711	28723	28707	28680
2 X 95	20.0/24.5	M1/5	28683	28723	27920	28678	21/4	28712	28723	28708	28678
2 X 95	24.5/29.0	M1/6	28683	28723	27920	28679	21/5	28712	28723	28708	28679
2 X 95	24.5/29.0	M1/6	28683	28723	27920	28680	21/6	28712	28723	28708	28680
2 X 70	11.0/15.5	M1/7	28684	28723	26373	28677	21/7	28713	28723	28709	28677
2 X 70	15.5/20.0	M1/8	28684	28723	26373	28678	21/8	28713	28723	28709	28678
2 X 70	20.0/24.5	M1/9	28684	28723	26373	28679	21/9	28713	28723	28709	28679
2 X 50/35	11.0/15.5	M1/10	28685	28723	27089	28677	21/10	28714	28723	28710	28677
2 X 50/35	15.5/20.0	M1/11	28685	28723	27089	28678	21/11	28714	28723	28710	28678
2 X 50/35	20.0/24.5	M1/12	28685	28723	27089	28679	21/12	28714	28723	28710	28679

5 Single Core Cable Types

Cable size mm ²	Cable dia mm min/max	Socket order ref	Double end socket front	Rear half	Double power tube	5 hole bung	Plug order ref	Double end plug front	Rear half	Double power pin	5 hole bung
4 X 70/95	14.5/18.0	M3/3									
4 X 70/95	18.0/21.0	M3/4	28704	28723	21362	28721	23/3	28717	28723	28715	28721
4 X 70/95	18.0/21.0	M3/4	28704	28723	21362	18286	23/4	28717	28723	28715	18286
4 X 50/35	11.0/14.5	M3/5	28705	28723	28706	27628	23/5	28718	28723	28716	27628
4 X 50/35	14.5/18.0	M3/6	28705	28723	28706	28721	23/6	28718	28723	28716	28721
4 X 50/35	18.0/21.0	M3/7	28705	28723	28706	18286	23/7	28718	28723	28716	18286

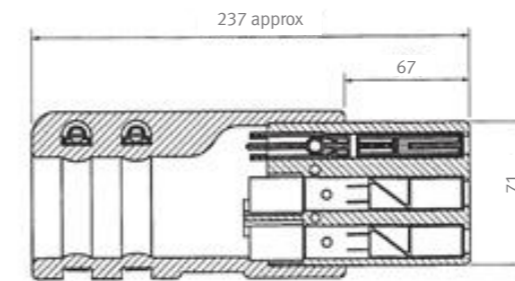

Socket

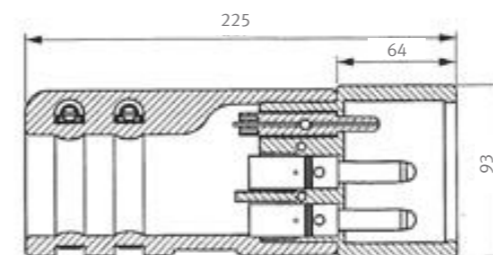
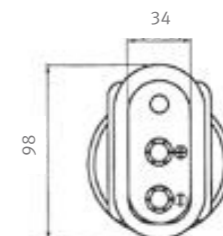

Plug



All dimensions in mm

Cable Assemblies & Harnesses



Bespoke assemblies and cable harnesses to meet customer requirements.

Extension Harness (EH), Power Harness (PH) and Dual Harness (DH) options available.

Features:

- Composite, 3 single core or 5 single core cable options
- 115 - 200VAC 400 Hz and 28VDC supply
- Quick assembly using standard stock items
- Cable length can be specified
- Lanyard fitting option available



Extension Harness (EH)



400 Hz Single Core Extension Harness with P400 & Type 15

28VDC Single Core Extension Harness with M3 & Type 23

Part Number Configurator - 400 Hz

P400	Fixed contact connector		
PD400	Detachable nose replaceable contact connector		

EH	Socket type	Cable type & size	Cable length	Lanyard fitting
-----------	-------------	-------------------	--------------	-----------------

Conductor sizes mm ²			
1	Single core	A, B & C N	95mm ² 95mm ²
2	Single core	A, B & C N	70mm ² 70mm ²
3	Composite	A, B & C N	70mm ² 35mm ²

Cable length in metres e.g. add 10.

For lanyard fitting add F.

Example code:

EHPD400215 - Extension harness with PD400 featuring 70mm² power cables, 15m of cable. This will be fitted with either a Type 14 or Type 15 plug depending on cable type. When ordering please specify if composite or multi core cable is required.

Part Number Configurator - 28VDC

M1	2 single core cables		
M3	4 single core cables		

EH	Socket type	Cable type & size	Cable length	Lanyard fitting
-----------	-------------	-------------------	--------------	-----------------

Conductor sizes mm ²			
1	Single core	+ power contact - power contact	120mm ² 120mm ²
2	Single core	+ power contact - power contact	95mm ² 95mm ²
3	Single core	+ power contact - power contact	70mm ² 70mm ²
4	Single core	+ power contact - power contact	2 x 70mm ² 2 x 70mm ²
5	Single core	+ power contact - power contact	2 x 95mm ² 2 x 95mm ²

Cable length in metres e.g. add 10.

For lanyard fitting add F.

Example code:

EHM1315 - Extension harness including Type M1 socket with 70mm² power cables, 15m of cable and a Type 21 plug.

Power Harness (PH)



400 Hz Single Core Cable Harness & P400



400 Hz Composite Cable Harness & PD400



28VDC 5 Single Core Cable Harness & Type M3

Part Number Configurator - 400 Hz

P400	Fixed contact connector	1	Standard control tube
PD400	Detachable nose replaceable contact connector	2	90% insertion tube with removable switch

PH	Socket type	Cable type & size	Control tube	Cable length
----	-------------	-------------------	--------------	--------------

Conductor sizes mm ²			
1	Single core	A, B & C N	95mm ² 95mm ²
2	Single core	A, B & C N	70mm ² 70mm ²
3	Composite	A, B & C N	70 mm ² 35mm ²

Cable length in metres e.g. add 10.

- Add **F** - lanyard fitting required.
- Add **L** - harness connector control contacts to be linked.
- Add **N** - harness connector neutral rupture to be wired.
- Add **LN** - harness connector contacts linked + neutral rupture to be wired.

Example code:
PHPD4001225LN - Power harness including PD400 detachable nose connector with 95mm² power cable, 90% insertion tube, 25m of cable. E&F are linked and neutral rupture is wired.

Part Number Configurator - 28VDC

M1	2 single core cables
M3	4 single core cables

PH	Socket type	Cable type & size	Cable length	Lanyard fitting
----	-------------	-------------------	--------------	-----------------

Conductor sizes mm ²			
1	Single core	+ power contact - power contact	120mm ² 120mm ²
2	Single core	+ power contact - power contact	95mm ² 95mm ²
3	Single core	+ power contact - power contact	70mm ² 70mm ²
4	Single core	+ power contact - power contact	2 x 70mm ² 2 x 70mm ²
5	Single core	+ power contact - power contact	2 x 95mm ² 2 x 95mm ²

Cable length in metres e.g. add 10.

For lanyard fitting add F.

Example code:
PHM3520 - Power harness including M3 connector (4 single core cables featuring 2 x 95mm² (+) and 2 x 95mm² (-) conductors attached to 20m of cable.

Dual Harness (DH)



Dual Harness with PJS400 & PDS400 complete with Exohook

Part Number Configurator

1	Amokabel 7x35mm ² + 18x1mm ²	0	No LEDs
2	BETAjet FRNC Smartflex V26x6mm ² + 6x35mm ² + 6x (4x1mm ²)	1	1 LED colour red
3	BETAjet 400 FRNC Drumflex 1x35mm ² + 6x35mm ² + 6x (3x1mm ²)	2	2 LEDs colours red & green
		3	3 LEDs colours red & green + 1 yellow
		4	4 LEDs colours red & green + 2 yellow
		5	1 LED colour green
		6	4 LEDs colours red & green + yellow & green

	Reeler cable (m)	Joiner cable (m)
A	18	1.5
B	18	2.0
C	18	2.5
D	24	1.5
E	24	2.0
F	24	2.5

1	Standard control tube
2	90% insertion tube with removable switch

1	ON (normally open), OFF (normally closed)
2	ON (normally open), OFF (normally open)

0	No temperature sensors required
1	PT100
2	PTC120
3	PTC100

1	Amokabel SII 4x1x50mm ² + (4x1mm ²) twisted	0	No push buttons
2	Amokabel SII 4x1x70mm ² + (4x1mm ²)	1	1 push button - green
3	BETAjet FRNC-Flex 4x1x50mm ² + (4x1mm ²)	2	2 push buttons - green & red
4	BETAjet FRNC-Flex 4x1x70mm ² + (4x1mm ²)	3	3 push buttons - green, red & black
5	BETAjet FRNC-Deltaflex 3x1x50/20mm ² + (8x1mm ²)	4	4 push buttons - green, red & 2 black
6	BETAjet FRNC-Deltaflex 3x1x70/25mm ² + (8x1mm ²)		

- Add **F** - lanyard fitting required.
- Add **L** - harness connector control contacts to be linked.
- Add **N** - harness connector neutral rupture to be wired.
- Add **LN** - harness connector contacts linked + neutral rupture to be wired.

Additional reeler and joiner cable options may be possible.

Example codes:

DH36E23401LN - Dual harness including 24m of BETAjet 400 FRNC Drumflex 1x35mm² + 6x35mm² + 6x (3x1mm²) and 2.0m of BETAjet FRNC-Deltaflex 3x1x70/25mm² + (8x1mm²), 90% insertion tube in PDS400 socket, 3 push buttons (red, green and black), 4 LEDs (red, green, 2 x yellow), no temperature sensor, switch wiring ON (normally open) OFF (normally closed), connector contacts linked and neutral rupture wired.

Cable Harness Storage Stand (PCR100)

Designed for use in the hanger or on the airport apron.

Features:

- 2 part bolted and welded aluminum construction
- Suits multicore and composite cables
- Holds 100kg per side (maximum)
- Bright yellow finish and fitted with high visibility reflective tape

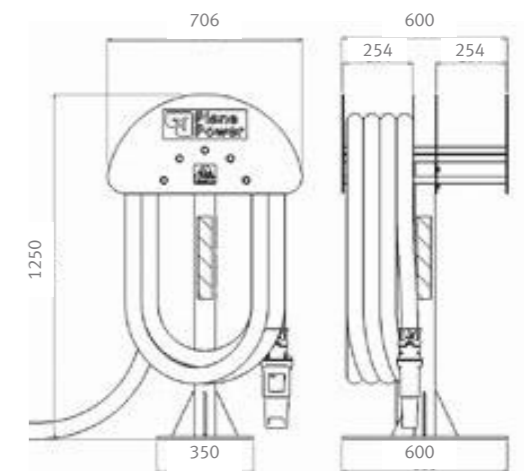

PJS400 Junction Sleeve (400 Hz)



Exohook (54657)



PJS400 Hanging bracket

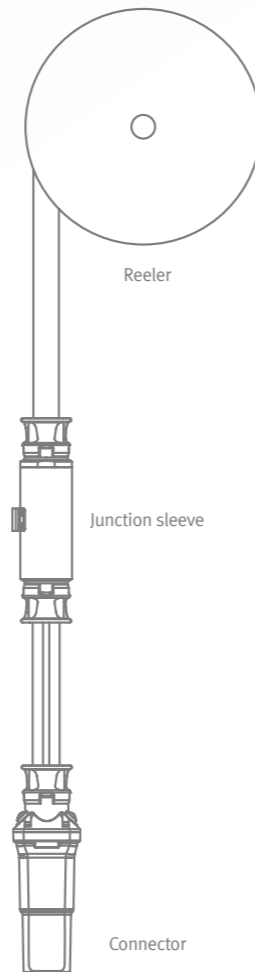

Part Number Configurator

A	To suit 1 x Ø 34.00-35.99mm cable	F	To suit 3 x Ø 19.00-20.99mm cable
B	To suit 1 x Ø 36.00-37.99mm cable	G	To suit 3 x Ø 21.00-23.00mm cable
C	To suit 1 x Ø 38.00-39.99mm cable	H	To suit 4 x Ø 16.00-17.99mm cable
D	To suit 1 x Ø 40.00-41.99mm cable	J	To suit 4 x Ø 18.00-19.99mm cable
E	To suit 1 x Ø 42.00-44.99mm cable	K	To suit 4 x Ø 20.00-22.00mm cable
		L	To suit 4 x Ø 14.00-15.99mm cable + 1 x Ø9.00-10.99 Cable
		M	To suit 4 x Ø 16.00-17.99mm cable + 1 x Ø9.00-10.99 Cable
		N	To suit 4 x Ø 14.00-15.99mm cable + 1 x Ø13.00-14.99 Cable
		P	To suit 4 x Ø 16.00-17.99mm cable + 1 x Ø13.00-14.99 Cable
		Q	To suit 4 x Ø 20.00-21.99mm cable + 1 x Ø8.50-9.99 Cable

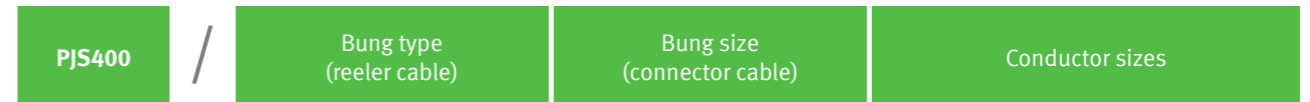

Conductor sizes mm ²					
1	A, B & C N	70mm ² 35mm ² to 50mm ²	Joining to	A, B & C N	35mm ² to 50mm ² 35mm ² to 50mm ²
2	A, B & C N	70mm ² 35mm ² to 50mm ²	Joining to	A, B & C N	70mm ² 70mm ²
3	A, B & C N	35mm ² to 50mm ² 35mm ² to 50mm ²	Joining to	A, B & C N	35mm ² to 50mm ² 35mm ² to 50mm ²
4	A, B & C N	35mm ² to 50mm ² 30mm ²	Joining to	A, B & C N	70mm ² 70mm ²
		Reeler cable			Connector cable

Example code:

PJS400/EH2 - This configuration joins single composite cable with outer diameter from 42.00mm to 44.99mm with conductor sizes of 70mm² (A, B and C) and 35-50mm² (neutral) to 4 single core cables with outer diameters of 16.00-17.99mm with conductor sizes of 70mm² (A, B and C) and 70mm² (neutral).

The PJS400 Junction Sleeve (400 Hz) is designed to connect composite cable to multicore cable. Configured to meet customer requirements, it is low maintenance and impact resistant.

Features:

- Provides safe and robust connection of differing cable types
- Ideal for use with cable retrievers/reelers
- Power supplies using composite cable can be joined to more flexible single core cable at the connector end
- External components manufactured from impact, abrasion and chemically resistant, thermally stable polymers

- Suitable for a wide range of composite and single core 400 Hz cables
- Exterior replaceable handle/strain relief system
- IP66 & IP67 rated (filler not required)
- Exohook supplied with the PJS400
- Nominal voltage: 115/200 V, 400 Hz
- Current carrying capacity: 450 A (power), 35 A (control)
- Current overload: 1500 A for 1 min (power)
- High-voltage test: 4000 V
- Operating temperature: -25°C to +90°C (including temperature rise)
- Weight: 1.7 kg uncabled and not filled

Technical information:

- Configurable bungs to suit industry standard cables
- Supplied with connector hanging bracket

PFR400 Flanged Receptacle

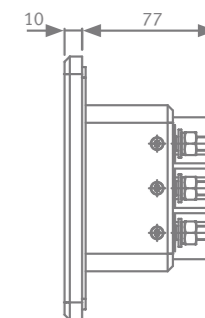
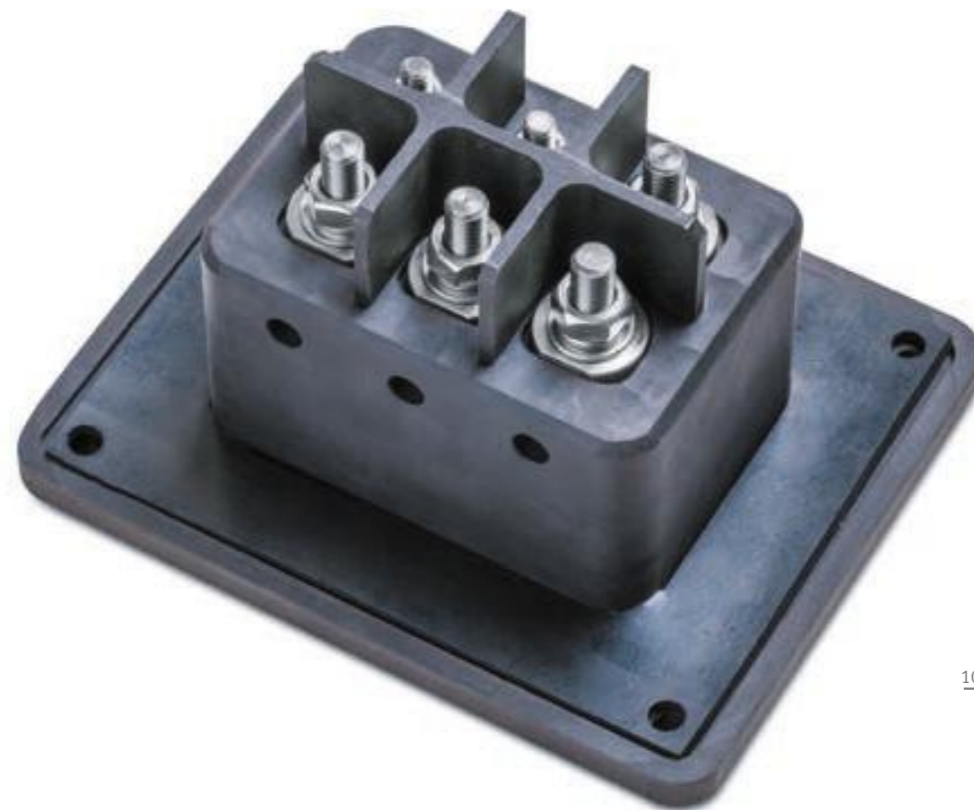

All dimensions in mm

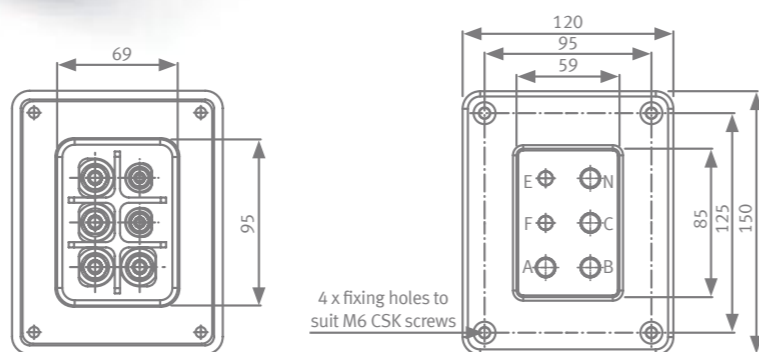

All dimensions in mm

Easy connection to cable & low maintenance.

Features:

- External components manufactured from impact, abrasion and chemically resistant, thermally stable polymers
- Connector interface ISO 461 compliant
- Threaded connections to suit standard lugs M8 power, M6 E & F
- Supplied with conformal gasket
- Low profile

Technical information:

- High conductivity silver plated copper contacts
- Easy cable attachment
- Replaceable contacts
- Nominal voltage: 115/200 V, 400 Hz
- Current carrying capacity: 450 A (power), 35 A (control)
- Current overload: 1500 A for 1 min (power)
- High-voltage test: 4000 V

- Operating temperature: -25°C to +90°C (including temperature rise)
- Weight: 1 kg
- Compatibility: Mates with ISO 461-2 and MS90362 receptacles

28VDC Flanged Plug & Socket



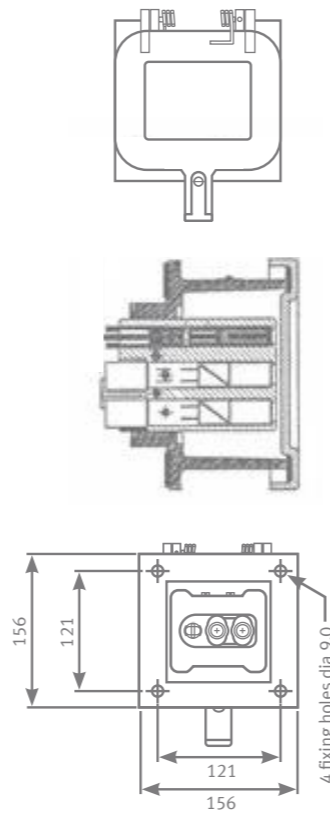

Type 19





All dimensions in mm

28VDC 3 Pole - Plug

Cable size mm ²	Plug order ref	Single end plug front	Single end pin	Double end plug front	Double end pin
2 x 120	19/1			-	-
2 x 95	19/2	28712	28708	-	-
2 x 70	19/3	28713	28709	-	-
2 x 50/35	19/4	28714	28710	-	-
4 x 95/70	19/6	-	-	28717	28715
4 x 50/35	19/8	-	-	28718	28716

28VDC 3 Pole - Socket

Cable size mm ²	Socket order ref	Single end socket front	Single end tube	Double end socket front	Double end tube
2 x 120	16/1			-	-
2 x 95	16/2	28683	27920	-	-
2 x 70	16/3	28684	26373	-	-
2 x 50/35	16/4	28685	27089	-	-
4 x 95/70	16/6	-	-	28704	21362
4 x 50/35	16/8	-	-	28705	28706



Type 16

Features:

- Cast aluminium alloy housing & lid
- Epoxy powder coated orange or black finish
- Interior compliant to ISO 461
- Assemblies complete with power & control pins or tubes
- Lid incorporates connector retaining tongue with padlocking facility
- Rated to IP54

- Single contacts can be either crimped or soldered. Double-ended contacts must be soldered
- Connector material: CSPE

Technical information:

Power Components

- 450 A maximum continuous current
- 1500 A for maximum 1 min

Control Components

- 35 A maximum continuous current
- All flanged plugs have a split control pin (part number - 29176) and all flanged sockets have a split control tube (part number - 13196)

400 Hz Flanged Plug & Socket



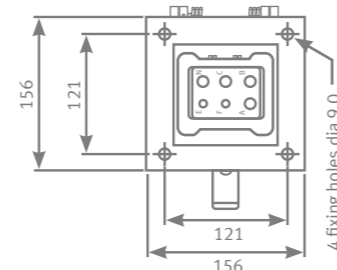
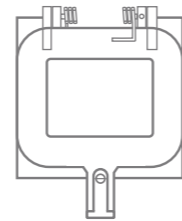
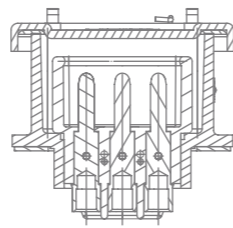

Type 18





All dimensions in mm

115-200VAC 400 Hz 6 Pole - Plug

Cable size mm ²	Plug order ref	Front half plug assembly	Power pin	Control pin
4 x 95	18/1	 28727	 28377	 26675
4 x 70	18/2	27299	26674	26675
4 x 50/35	18/3	28726	27884	26675

115-200VAC 400 Hz 6 Pole - Socket

Cable size mm ²	Socket order ref	Front half socket assembly	Power tube	Control tube
4 x 95	10/1	 28845	 27920	 26374
4 x 70	10/2	27298	26373	26374
4 x 50/35	10/3	27418	27089	26374



Type 10

Features:

- Cast aluminium alloy housing & lid
- Epoxy powder coated orange or black finish
- Interior compliant to ISO 461
- Assemblies complete with power & control pins or tubes
- Lid incorporates connector retaining tongue with padlocking facility
- Rated to IP54

- Single contacts can be either crimped or soldered. Double-ended contacts must be soldered
- Connector material: CSPE

Technical information:

- Power Components**
- 450 A maximum continuous current
 - 1500 A for maximum 1 min

Control Components

- 35 A maximum continuous current
- All flanged plugs have a split control pin (part number - 29176) and all flanged sockets have a split control tube (part number - 13196)

Flanged Connector Mounting Boxes



Type 27121
Surface Box

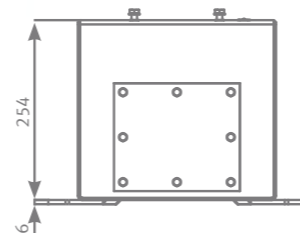
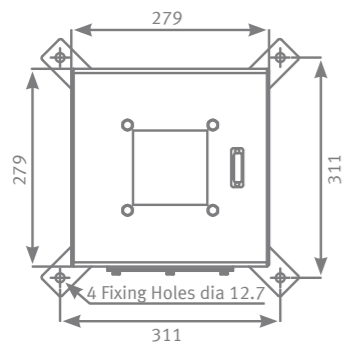

All dimensions in mm



Type 27012
Angle Adaptor Box

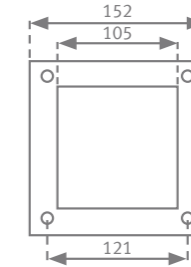

All dimensions in mm

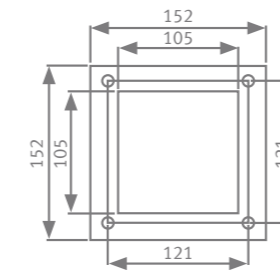

IP54 rated with flanged connector installed.

Features:







- Designed for use with flanged connector Types 10, 16, 18 & 19
- IP54 rated with flanged connector installed
- Manufactured in mild steel and zinc sprayed, with a polyester powder coated orange or black finish
- Cuboid design with side entry allows orientation to meet installation requirements
- Type 27121 gland plate accommodates most cable types and sizes
- Type 27121 supplied with flange connector fixing bolts
- Type 27012 supplied with fixing bolts and sealing gasket

Spares & Accessories



We offer a range of spares and accessories to support our customers. To find out more or check stock availability contact us on sales@lpa-connect.com and +44 (0)1799 512800.



Spares & Accessories

Spare part	Name & description	Part No.	Spare accessory for
	Connector nose	54357	PDS400 PD400
	Handle assembly With screws and washers	54466	PDS400 PD400 P400 PJS400
	Black switch With fixing nut and switch cover	54469	PDS400
	Green switch With fixing nut and switch cover	54468	PDS400
	Red switch With fixing nut and switch cover	54467	PDS400
	LED lights With spring washer and O ring Red Green Yellow	54470 54471 54472	PDS400

Spares & Accessories

Spare part	Name & description	Part No.	Spare accessory for
	Switch cover Replaceable silicone switch boot	53765	PDS400
	Control tube front half assembly	54354	PDS400 PD400
	Power tube front half assembly	54355	PDS400 PD400
	90% insertion tube front half assembly	54449	PDS400 PD400 P400
	90% insertion tube switch	52544	PDS400 PD400 P400

Spares & Accessories

Spare part	Name & description	Part No.	Spare accessory for
	Exohook Hanging hook for the PDS400/PJS400 when used with the PJS400 and PD400	54657	PDS400 PD400
	Cable Guard Spiral cable guard to protect the cable harness. Inside diameter of 60mm, available in black, orange and yellow.	54822/BLK 54822/ORG 54822/YEL	All cable harnesses
	Socket protection cap DC socket protection cap	54749 29597	PDS400 PD400 P400 M1 M3
	Aircraft socket assembly kit	51722	PDS400 PD400 D400 D410 N27 P27
	Plane Power lanyard assembly	55426	Designed to reduce the strain on the aircraft socket caused by the weight of the power cable harness.

Technical Information

NATO Stock References

Performance and dimensions of LPA Connection Systems aviation ground power supply connectors comply with BS ISO 461-1, BS ISO 461-2, BS 4G 178-2, Add BS 4G 173 Part 1 and to appropriate Ministry of Defence (Air) and NSN standards.

General assembly:

Tubes and pins are retained in moulded plastic or rubber housings by stainless steel circlips or nylon fixing pins. Front and rear housings are secured together by stainless steel fixings, thus facilitating disassembly and easy access to pins and tubes when attaching the cable. The connector is secured to the cable by two stainless steel screw clamps or by pot and bung design, providing excellent strain relief and weatherproof seal.

A heat shrink sleeve covering the cable entry and rear housing can be supplied as an option.

Front and rear housings:

Housings are moulded or machined from glass reinforced nylon, nitrile PVC or CSPE, compounds selected for

their resistance to UV light, moisture, chemicals abrasion and other hazards / wear and tear associated with aircraft maintenance areas, with a temperature range of -40°C to +100°C.

Power & control pins & tubes:

Pins and tubes are machined from copper and silver plated to ensure excellent electrical conductivity. Tubes incorporate a spring mechanism ensuring positive electrical contact in accordance with ISO 461-1/BS 4G 173.

Cable termination:

Power pins and tubes:

With the exception of the Type M3 and Type 23 connectors, which must be soldered, power pins and tubes may be connected to cables by soldering or crimping. Termination guide (Ref 29273) available on request.

Control pins and tubes:

With the exception of the split design F tube and pin on 28VDC connectors which must be soldered, control tubes and pins may be connected to cables by soldering or crimping. The electrical

and load test approvals to BS 4G 178-2 & ISO 461 require the use of the appropriate crimping dies as shown in the product selection charts. Conductors under 2mm² will require doubling over to provide a satisfactory crimped connection.

Crimping tests have been conducted using conductor sizes shown in tables in BS 638. Oversheath dimensions are for power cables to BS 638, BS 6004 and BS 6007. Control cables are to BS 6500.

Heat shrink sleeves, supplied as standard by LPA, should be fitted over the connection and cable end of all power pins and tubes.

It is recommended that, following connection but before mating front and rear assemblies together, the rear assembly is filled with RTV silicone sealant (ACC Silicones AS1602 or AS1603) to prevent any possible moisture ingress (only on legacy connectors).

LPA Group Plc reserves the right to modify designs and specifications so as to permit the incorporation of technical developments.

NSN	LPA part number	Where used
5935-99-393-4883	P400/21M	
5935-99-340-3621	P400/21L	
5935-99-495-1220	P400/21E	
5935-99-368-1700	P400/41A	
5935-99-349-7070	P400/21F	
5935-99-671-7647	P400/22M	
5935-99-564-4321	P400/22P	
5935-99-344-4526	PD400/21M	
5935-99-551-2589	Type 40/2	
5935-99-758-1104	Type 40/4	
5935-99-192-2528	Type 40/6	
5935-99-785-7295	Type 40/8	
5935-99-434-9740	Type 41/3	
5935-99-203-1199	Type M1/C	
5935-99-770-3267	Type M1/5	
5935-99-010-0617	Type M1/7	
5935-99-434-9738	Type M3/3	
5935-99-244-2408	Type M3/4	
998475867	Type 10/1	
5935-99-608-3168	Type 10/2	
5935-99-282-4558	Type 18/2	
5935-99-810-3422	Type 15/4	
992586194	Type 16/6	
5935-99-461-3781	Nose moulding excluding contacts 33580	D410/D400
5935-99-551-0426	Power tube detachable front half 33526	Type D400/Type D410
5935-99-498-8657	Control tube detachable front half 33530	Type D400/D410
5935-99-867-8041	400 Hz protection cap	Type D400/D410/Type 400/D400
5935-99-192-6707	Tube retaining peg 11945	Type 400/Type 410
5935-99-192-6693	28VDC power tube retaining peg 13175	Type M1/M3
5935-99-192-6692	28VDC control tube retaining peg 13176	Type M1/M3
5935-99-193-2920	28VDC control tube split pin type	Type M1/M3
5999-99-205-4971	Control tube	Type 40/41
5999-99-117-8495	Power tube assembly 70/95mm	Type M3
5999-99-528-3584	Power tube 70mm 26373	Type M1/M7
5999-99-301-2920	Power tube 35/50mm 27089	Type 40/8
5999-99-051-8636	Power tube assembly	Type M1/5, Type M1/7, Type 10/1, Type 40/1

lpa connection systems

Light & Power House,
Shire Hill, Saffron Walden,
CB11 3AQ, UK
+44 (0)1799 512800
enquiries@lpa-connect.com

LPA Group Plc

Light & Power House,
Shire Hill, Saffron Walden,
CB11 3AQ, UK
+44 (0)1799 512800
enquiries@lpa-group.com

LPA Channel Electric

Bath Road,
Thatcham, Berkshire,
RG18 3ST, UK
+44 (0)1635 864866
enquiries@lpa-channel.com

LPA Lighting Systems

LPA House, Ripley Drive,
Normanton, West Yorkshire,
WF6 1QT, UK
+44 (0)1924 224100
enquiries@lpa-light.com

www.lpa-group.com



FM 759856

EMS 758363



FM 01660

LPAPub.No.100/0823/200